

electriciQ

USER MANUAL

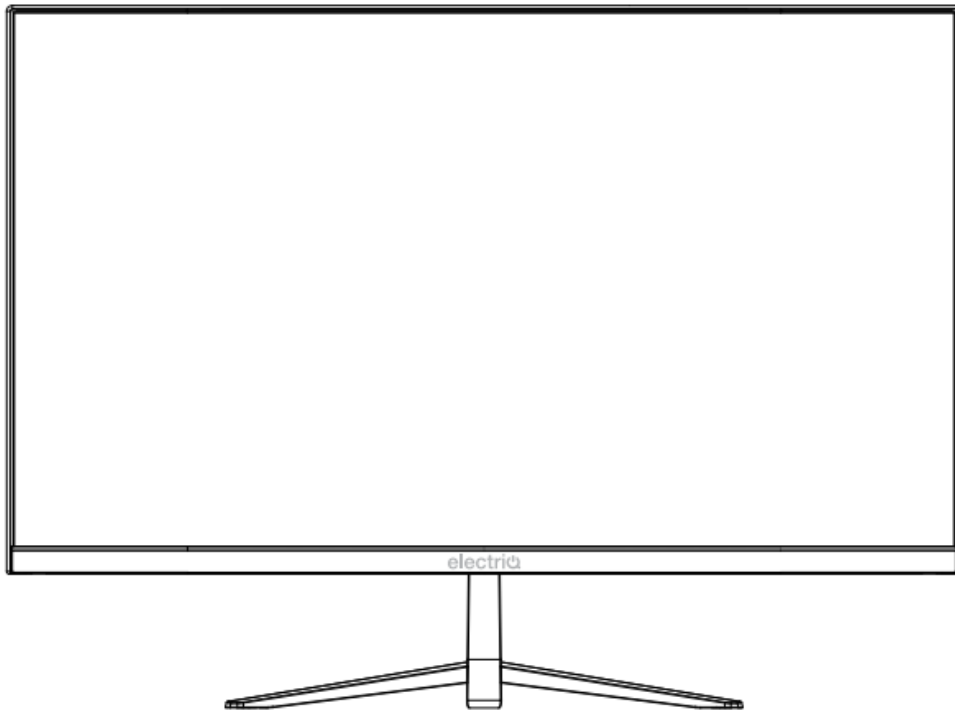

27 INCH SLIM LED MONITOR eiQ-27MF75I-V2

Thank you for choosing electriciQ
Please read the user manual before using this monitor and keep it safe for future reference
Visit www.electriQ.co.uk to view our entire range of Intelligent Electricals.

SETTLING IN OK?

We hope this has been helpful to you.

We would love to see how you're getting on with your new purchase, so please share any snaps you have on the platform of your choice below.

Our community awaits your uploads - Snap, tag and hashtag away!



@electriQUK

#electriQUK

WE'RE HERE TO HELP

Should you have any problems or questions with your purchase, please contact a member of our customer service team.

☎ 0330 390 3061

✉ support@electriQ.co.uk

Mon-Fri | 9am to 5pm

Unit J6, Lowfields Business Park,
Lowfields Way, Elland
West Yorkshire, HX5 9DA

CONTENTS



SAFETY INFORMATION	3
WHAT'S INCLUDED	5
CONNECTIONS AVAILABLE ON THE MONITOR	6
WALL MOUNTING	6
GETTING STARTED	7
MONITOR CONTROLS	7
INITIAL SETUP	8
MENU OPTIONS	8
LUMINANCE SETTINGS	9
IMAGE SETUP SETTINGS	9
COLOR SETUP SETTINGS	10
OSD SETUP SETTINGS	10
RESET	11
EXTRA	11
SPECIFICATION	12
electriQ UK SUPPORT	13

SAFETY INFORMATION

- Read these instructions - All the safety and operating instructions should be read before this product is operated.
- Keep these instructions - The safety and operating instructions should be retained for future reference.
- Heed all warnings - All warnings on the appliance and in the operating instructions should be adhered to.
- Follow all instructions - All operating and usage instructions should be followed.
- Do not use this equipment near water, or in humid environments – The appliance should not be used near water or moisture e.g. in a wet basement or near a swimming pool.
- Clean only with a dry cloth. Do not use solvents or petroleum-based fluids.
- Do not block any ventilation openings.
- Do not install near any heat sources such as radiators, stoves or other apparatus (including amplifiers) that produce heat.
- Do not tamper with the supplied plug. This plug is a BS1363 standard plug.
- Protect the power cord from being walked on or trapped, particularly at the plug and at the point where it exits from the appliance.
- Only use attachments/accessories specified by the manufacturer.
- Use only with a cart, stand, tripod, bracket or table specified by the manufacturer or sold with the apparatus. When a cart or stand is used, use caution when moving it to avoid any injuries or damage from it tipping over.
- Unplug the apparatus during lightning storms or when unused for long periods of time.
- Refer all servicing to qualified personnel. Servicing is required when the apparatus has been damaged in any way, such as if the power supply cord or plug is damaged, liquid has been spilled or objects have fallen into the apparatus or it has been exposed to rain or moisture, it does not operate normally or has been dropped.
- Please keep the unit in a well-ventilated environment.
- The monitor should only be connected to a mains power supply as rated on the back of the equipment.
- To prevent overload, do not share the same power supply socket with too many other electronic components.
- Do not place any connecting wires where they may be stepped on or tripped over.
- Do not place heavy items on the cable as this may cause damage.
- When removing from a socket hold by the plug and not the wires.
- Disconnect the power immediately and seek professional help if the plug or cable is damaged, liquid has spilt onto the unit, if accidentally exposed to water or moisture, if anything accidentally penetrates the ventilation slots or if the unit does not work normally.
- Do not remove the safety covers. There are no user serviceable parts inside.

Trying to service the unit yourself is dangerous and may invalidate the product's warranty. Only qualified personnel should service this apparatus.

- Do not block ventilation slots on the back cover. The monitor can be placed in a cabinet but ensure at least 5cm (2") clearance all around. Do not tap or shake the screen, this may damage internal components.
- Due to our continuous product development, the operation and or features of the product received may vary slightly from the information provided within the manual.
- **WARNING:** To reduce the risk of fire or electric shock, do not expose this apparatus to rain or moisture. The apparatus shall not be exposed to dripping or splashing and objects filled with liquids, such as vases, shall not be placed on the apparatus.
- **WARNING:** The wall plug socket is used as a disconnection device and should remain readily accessible.
- **WARNING:** The batteries shall not be exposed to excessive heat such as direct sunlight or fire.

	AT FULL VOLUME, PROLONGED LISTENING MAY DAMAGE THE USER'S HEARING.	
 <p>This warning sign is to warn of dangerous voltage inside the product.</p>	<div style="border: 2px solid black; padding: 5px; text-align: center;">CAUTION <small>RISK OF ELECTRIC SHOCK, DO NOT OPEN</small></div> <p>CAUTION: To reduce the risk of electric shock, DO NOT remove the cover (or back). No user serviceable parts inside. Refer servicing to qualified service personnel.</p>	 <p>This warning sign is to alert you of important instructions accompanying the product.</p>

WHAT'S INCLUDED



USER MANUAL

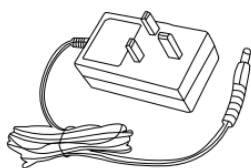

POWER SUPPLY

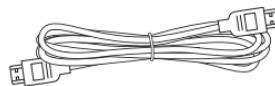

HDMI CABLE

DIMENSIONS

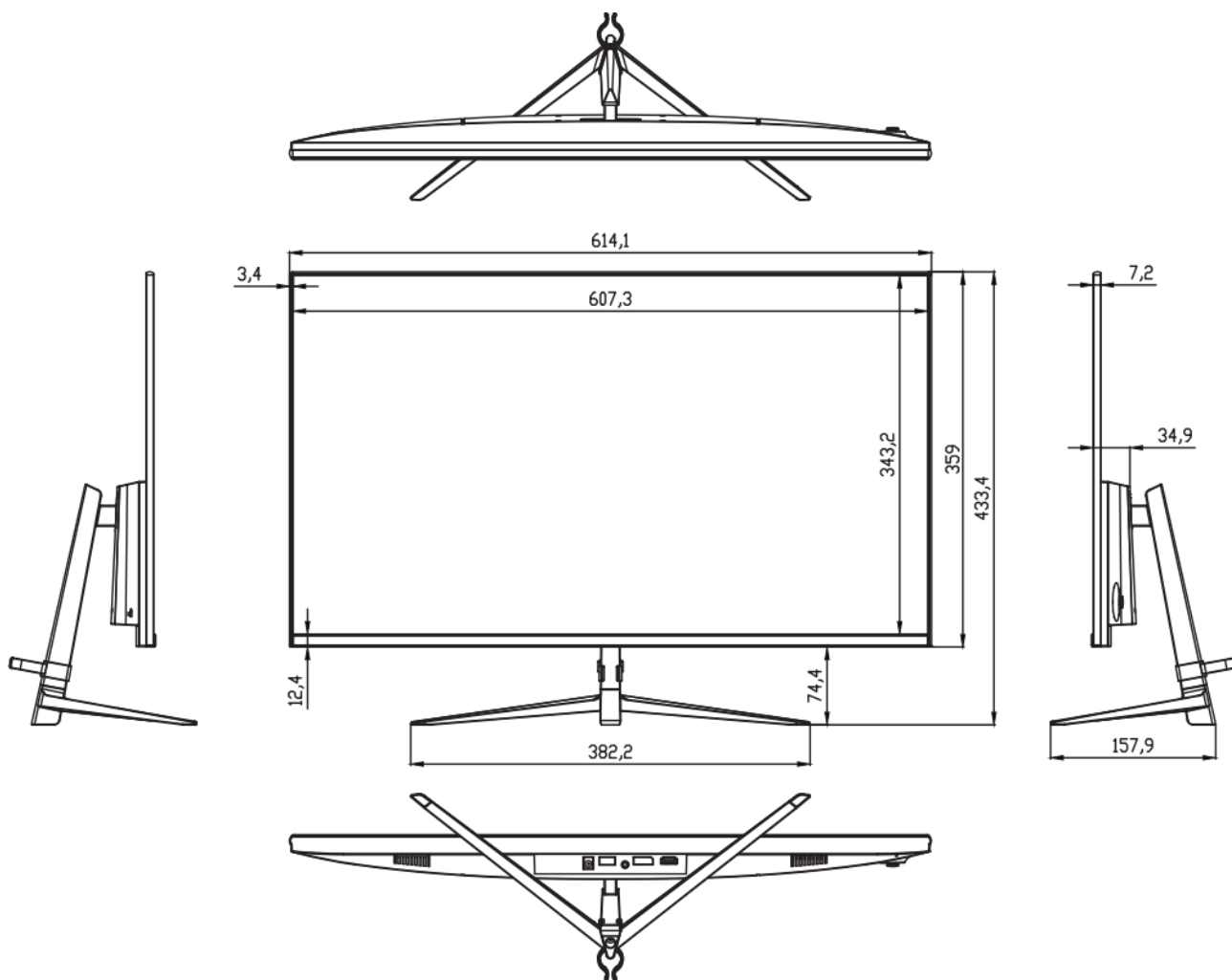

CONNECTIONS AVAILABLE ON THE MONITOR

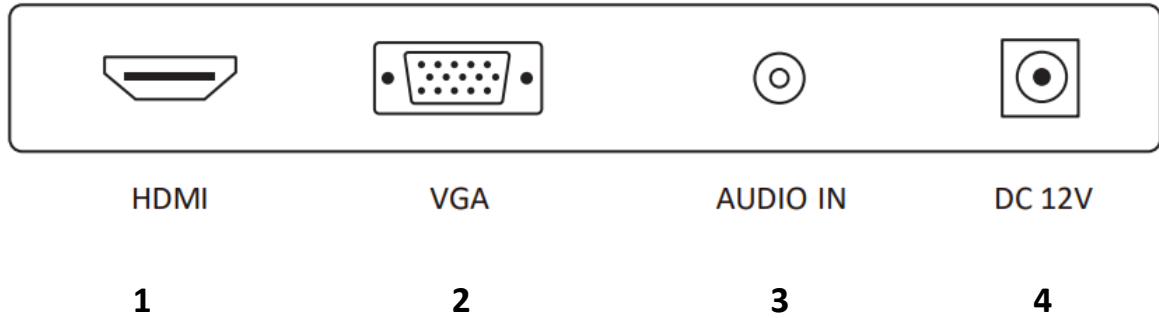

1. HDMI port: Used to connect a compatible device. Supports HDMI 1.4 & 2.0;
2. VGA: Used to connect a compatible VGA device
3. Audio In: Used for connecting headphones, or external speakers. The audio input is used in conjunction with the VGA input if a HDMI source is in use, the sound will come from the HDMI connection.
4. DC input port: Connect the supplied power supply to power the monitor

WALL MOUNTING

The monitor is provided with mounting holes for a VESA approved wall mounting bracket (not supplied)

The VESA mounting pattern is: 100x100mm and the size of the screws is 4 x M4 x 8 (not supplied)
Do not use screws longer than specified or damage will occur to the internal components.

NOTE: As the monitor is considered heavy, please consult with a professional wall mount installer to perform the installation.

GETTING STARTED

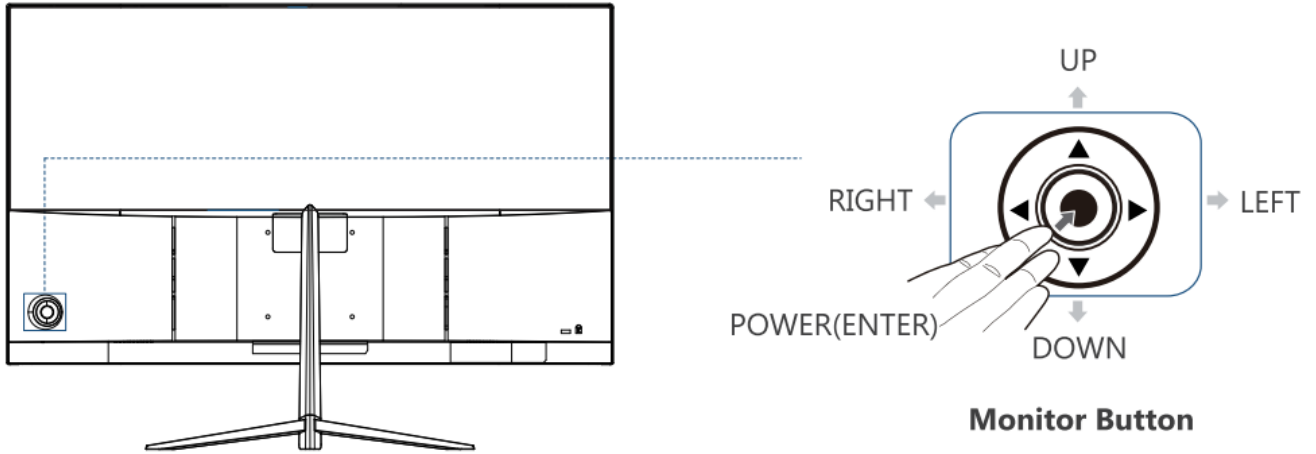

MONITOR BUTTONS

The monitor button is located on the rear left side of the monitor. The button can be used to move up, down, left or right within the menus. The center button is used as enter.

When the monitor has no display, the monitor buttons can be used as below:

●	Press once to turn the monitor on. Press again to enter the function guide. Press to confirm the chosen setting.
◀	Select the signal source. Press again to exit.
▶	ECO mode (Standard, Game, Movie, Internet, Text)
▲	Adjust the contrast.
▼	Adjust the brightness.

MONITOR CONTROLS

M	Enter into OSD menu and select an item for confirming settings
◀	Move down/ reduce value in the OSD menu; Display HDR Menu
▶	Move up / reduce value in the OSD menu; Display LOS (Crosshairs)
E	Go back to previous menu, exit the on-screen display, and display source menu.
●	Press once to turn the monitor on. Press again to enter the function guide. Press to confirm the chosen setting.

INITIAL SETUP

Connect the monitor to a power outlet.

1. Press the POWER button on the monitor to turn it on (The indicator will be blue)
2. Connect the relevant cable to the corresponding input on the monitor. The source will be automatically detected.
3. To change between inputs, press the "E" button to enter the source menu. Use the "◀" and "▶" buttons to choose the input source between VGA and HDMI.

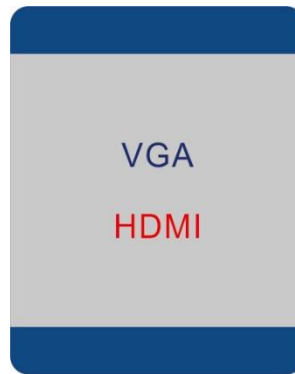

MENU OPTIONS

The menu for the monitor can be accessed by pressing the middle button on the control panel. This menu is separated into the following sub menus: Luminance, Image Setup, Colour, Setup, OSD Setup, Reset and Extra, details of each menu can be found in the following sections.



LUMINANCE SETTINGS

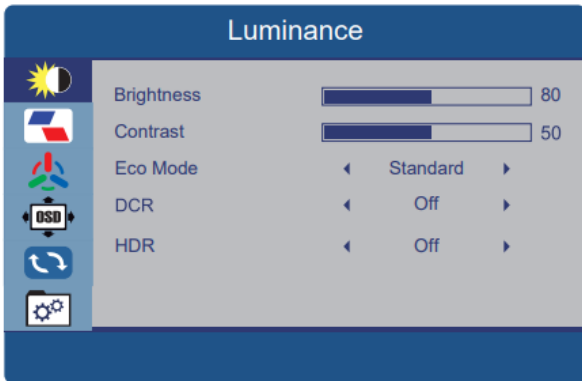

BRIGHTNESS

Allows the adjustment of the image brightness, according to ambient light in the room between "0-100"

CONTRAST

Allows the adjustment of contrast between white and black areas of the image between "0-100"

ECO MODE

Allows selection of image settings between the following: STANDARD, MOVIE, INTERNET and GAME.

DCR

Allows the dynamic contrast of the picture to be turned ON and OFF

HDR

Allows the HDR of the picture to be turned ON or OFF.

IMAGE SETUP SETTINGS

H. POSITION (VGA ONLY)

Allows adjustment of the horizontal position of the display image. Use the "◀" and "▶" buttons to horizontally move the image.

V. POSITION (VGA ONLY)

Allows adjustment of the vertical position of the display image. Use the "◀" and "▶" buttons to vertically move the image.

CLOCK (VGA ONLY)

Allows adjustment of the CLOCK setting between "0-100"

PHASE (VGA ONLY)

Can reduce video distortion and instability. Adjust between "0-100"

IMAGE RATIO

Allows the Image Ratio of the picture to be changed between WIDE and 4:3.

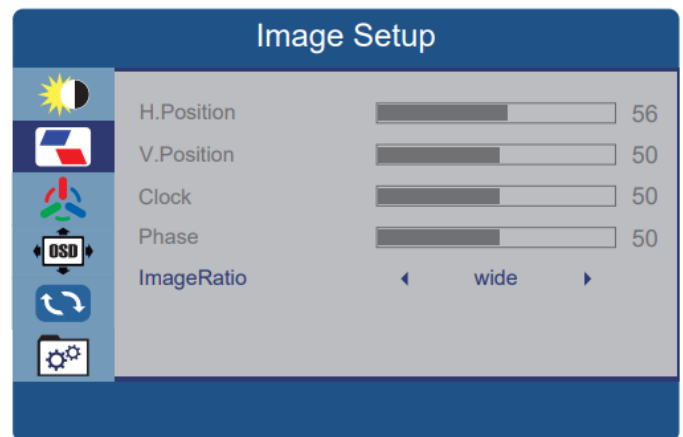

COLOUR SETUP SETTINGS

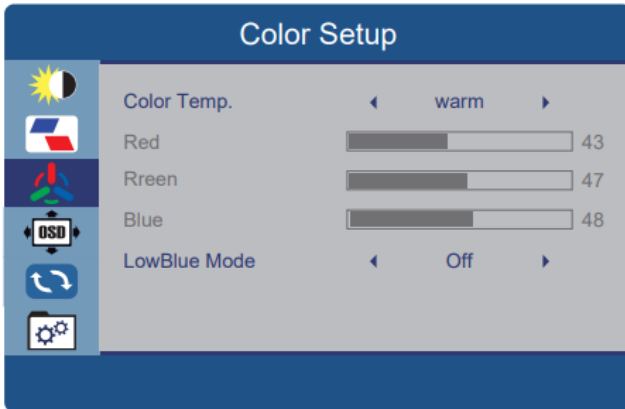

COLOR TEMP.

Allows adjustment of the colour settings between the following options: Warm, Normal, User and Cool.

RED

Allows adjustment of the red element of color for the image

GREEN

Allows adjustment of the green element of color for the image

BLUE

Allows adjustment of the blue element of color for the image

LOW BLUE MODE

Allows adjustment of the Low Blue Mode between the following options: OFF, Weak, Medium, Strong.

OSD SETUP SETTING

LANGUAGE

Allows selection of desired language

H. POSITION

Allows adjustment of the horizontal position of the OSD

V.POSITION

Allows adjustment of the vertical position of the OSD

TIMEOUT

Allows adjustment of the duration of the OSD between 5 and 100"

TRANSPARENCY

Allows adjustment of the transparency of the OSD between "0-100".

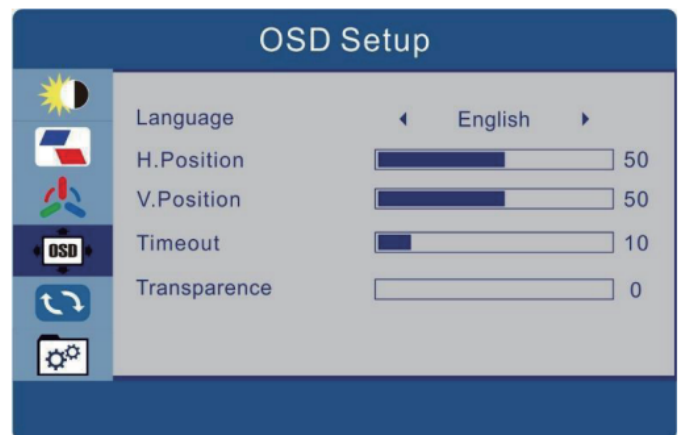

RESET

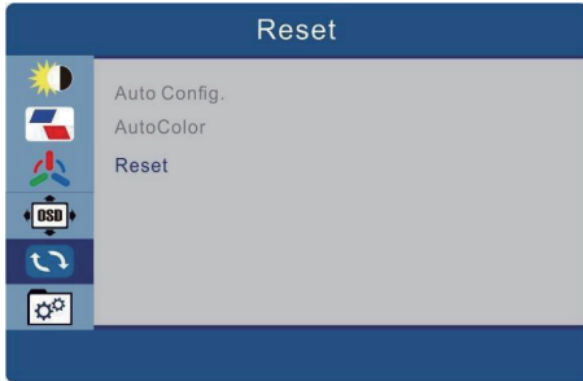

AUTO CONFIG.

Auto adjusts the image.

AUTO COLOR

Auto adjusts the colour of the image.

RESET

Returns the monitor to its factory default settings.

EXTRA

INPUT SELECT

Allows user to choose the signal source for the display between "HDMI, VGA".

MUTE

Allows Mute to be turned ON and OFF

VOLUME

Allows adjustment of the volume of the monitor from "0-100".

FREESYNC

Allows Freesync to be turned ON or OFF.

FLICKER FREE

Allows the flicker free to be turned ON or OFF.

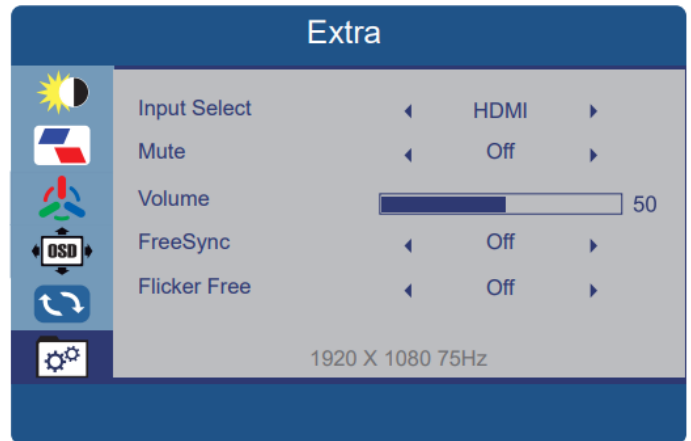

SPECIFICATION

eiQ-27MF75I-V2	
Panel Type	27"
Case Type	Plastic
Best Resolution	1920(H) x 1080(V)
Active Display Area	597.888 (H) X 336.312 (V)
Pixel Pitch	0.3114 (H) x 0.3114 (V)
Contrast Ratio	1000:1 Typical
Brightness	250 cd/m ²
Response Time	5ms(G2G)
Viewing Angle	U/D: 89° / 89°, L/R: 89° / 89°
Display Colours	16.7M
Adjustable Colour Temperature	WARM/ COOL /USER /NORMAL
Video Compatibility	Multi-Standard for NTSC / PAL
Aspect Ratio	16: 9
Speaker Multimedia Speakers	Right x 1 Left x 1, 2X2W
Sound Demodulation	Stereo. Audio
Mute	Yes
Operating Humidity	20 % - 70 %
Operating Temperature	- 10 to 40 °C
Wall mountable	100x100mm
IN/OUT INTERFACE	
Video Interface	HDMI + VGA
Audio Interface	Audio Inx 1
Safety & EMC Certification	CE / FCC / ROHS
Stand Type	Desktop
Button Position	Right Hand Side
POWER Voltage	DC12V / 3A
Power Consumption	32W

TROUBLESHOOTING

Problem	Solution
No power	Insert the plug securely into the power outlet.
No picture	Ensure that the equipment is connected properly.
	Ensure the correct input is selected.
No button response	Disconnect the power plug and then reconnect it. (The unit may not be operating properly due to lightning, static, or other factors.)
Noise or other interference	Electronic equipment near the unit may be causing interference. Relocate the unit or move the equipment.

ENVIRONMENTAL PROTECTION

Waste electrical products should not be disposed of with household waste. Please recycle where facilities exist. Check with your Local Authority or retailer for recycling advice.



electriQ UK SUPPORT

www.electriQ.co.uk/support

If the unit fails to operate call: 0330 390 3061 or complete the online form Office hours: 9AM - 5PM Monday to Friday

www.electriQ.co.uk

Unit J6, Lowfields Business Park
Lowfields Way, Elland
West Yorkshire, HX5 9DA